

MILITARY / AEROSPACE / GOVERNMENT

Explore, Acquire, Analyze, Decide.
Deliver Sooner, Better.

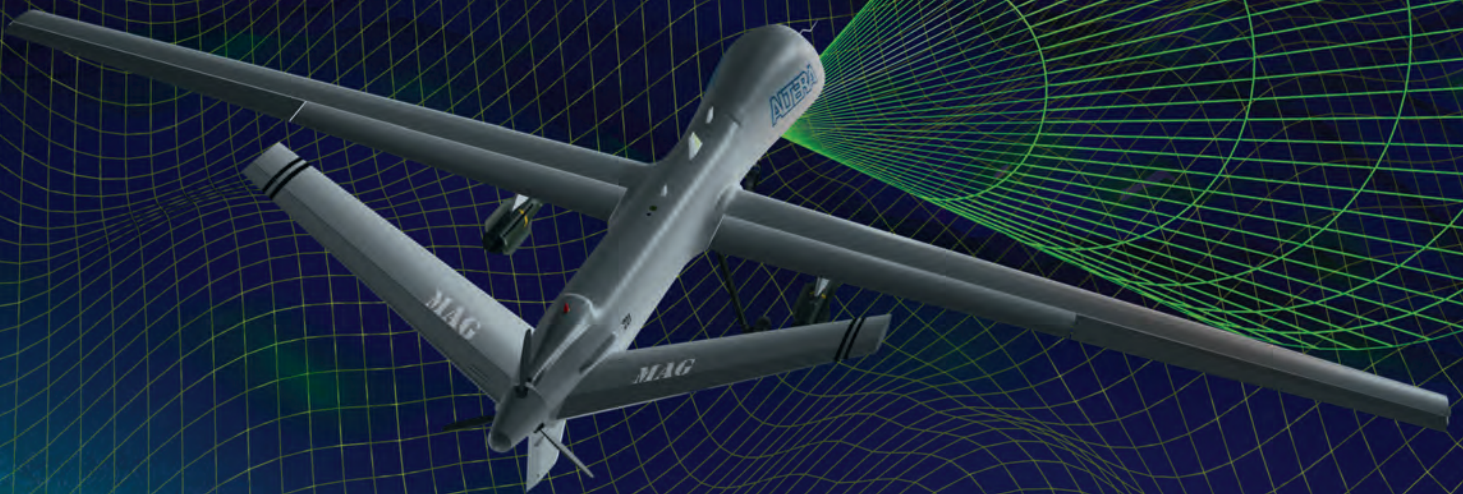

ATRERA[®]
MEASURABLE ADVANTAGE™

System Expertise

Military Communications
ISR, Radar, EW
Avionics, Missile Defense
Intelligence / Cyber Security
Space

Productivity & Technology

Unparalleled Productivity
OpenCL™
Full-Throttle Performance
Best-in-Class IP

Design Flow

FPGA Designers
GPU Programmers
Embedded Developers

Altera
Military / Aerospace / Government
Solutions Portfolio



Explore **more ideas** quickly.

Acquire new concepts **easily**.

Deliver designs **sooner, better**.

You **win**.

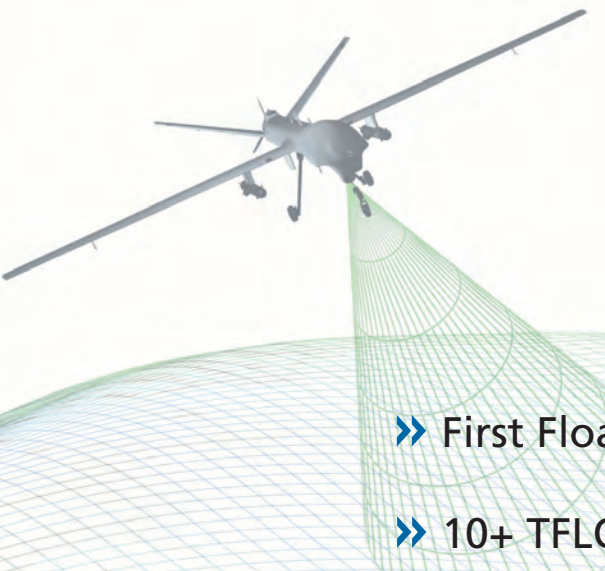
- 
- »» First Floating-Point FPGA
 - »» 10+ TFLOPS at 100 GFLOPS/Watt
 - »» 500 GFLOPS FFT 50 Gbps FFT Generation
 - »» Cholesky and QRD Up to 1,000,000 Matrices/Sec
 - »» Industry's Longest Product Life Cycle
 - »» OpenCL Conformant
 - »» Only On-Shore, High-End FPGA Fabric

Military / Aerospace / Government

System Expertise



Military Communications

- 28 Gbps serializer/deserializer (SERDES) transceivers
- Densest logic count in small-form-factor (SFF) packages
- Cryptographic partner IP cores
- Government-approved design methodologies
- Assured design for information assurance



ISR, Radar, EW

- Solution for digitization of phased-array antennas
- Fastest digital signal processing (DSP) blocks
- Comprehensive floating point and linear algebra library
- Modular Open Systems Architecture — commercial off-the-shelf (COTS) solutions
- System Integration Framework for rapid system development



Avionics, Missile Defense

- Support for DO-254 and DO-178C
- Package and radiation reliability report
- Guidance and control IP with reference designs



Intelligence / Cyber Security

- OpenCL accelerator FPGA cards
- High-performance IP for Cyber
- Enable software developers to program FPGAs
- Open Source Security and extensive ecosystem
- Expedite time to mission



Space

- Latch-up immunity
- Radiation test report and analysis
- LEO application-capable
- Custom screening and bare die

Productivity & Technology

Unparalleled Productivity

- Hardware in the Loop integrated reference designs
- DSP Builder Advanced Blockset is high-level, schematic-entry design:
 - Constraint-driven design (select f_{MAX} , latency, number of channels, device family, etc.)
 - Single datapath logic system clock
 - Automatic pipelining, register balancing
 - Fast, automatic timing closure

OpenCL

- Productivity: heterogeneous design platform including FPGA
- Performance: optimum throughput and latency for data and task-parallel algorithms
- Efficiency: industry-leading performance per watt

Full-Throttle Performance

- Industry's first floating-point FPGA
- 10 TFLOPS at 100 GFLOPS/Watt
- Up to 26 TMACs and 1 GHz fabric
- Common environment for system architect and design engineers

Best-in-Class IP

- Finite impulse response (FIR) filters
 - Support multichannel, time-division multiplexed (TDM), and sample rate \gg clock rate
- Fast Fourier transforms (FFTs) fixed and floating point
- Cascaded Integrator Comb (CIC) filters and waveform generating or mixing blocks
- Largest, fastest portfolio of floating-point functions

Design Flow

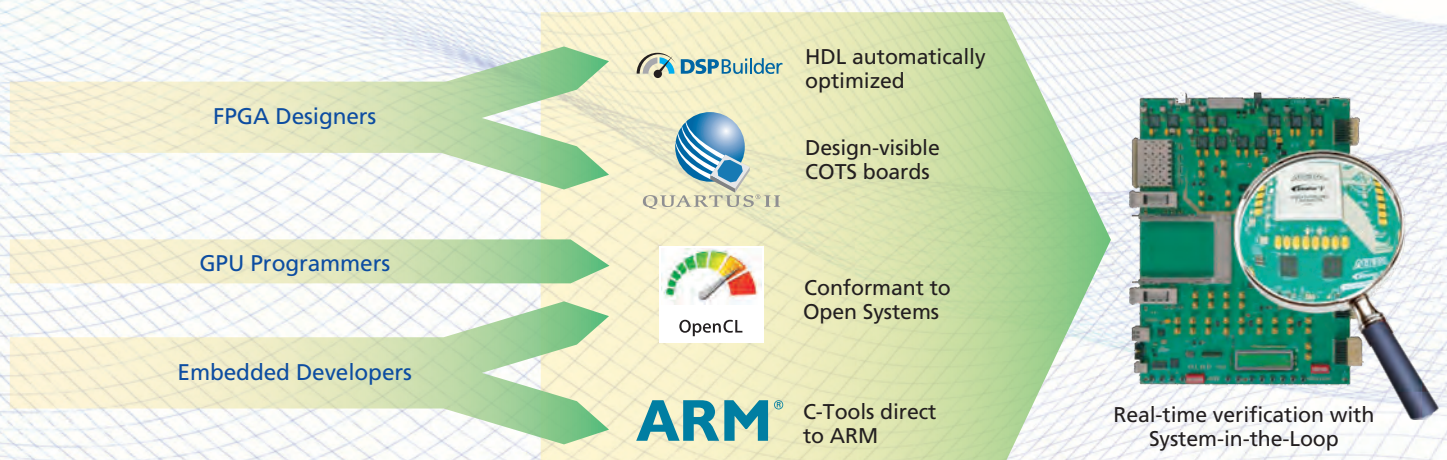

Solutions & Benefits

Digital Beamforming with System-in-the-Loop

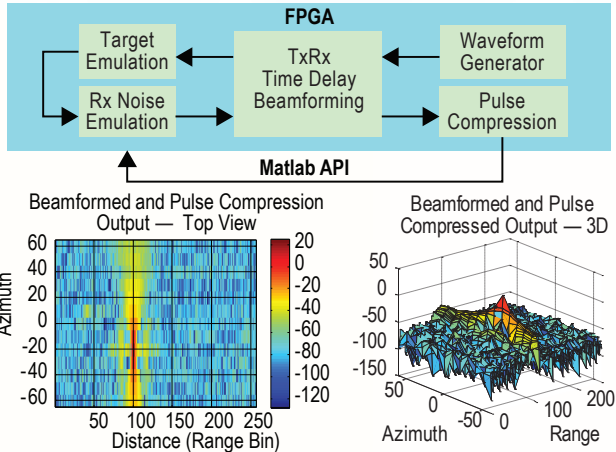

Pulse Doppler Processing

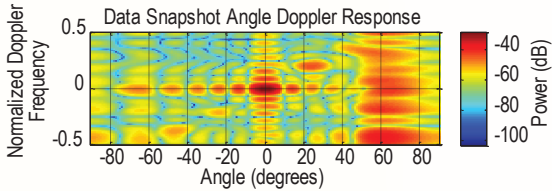

Space Time Adaptive Processing (STAP)

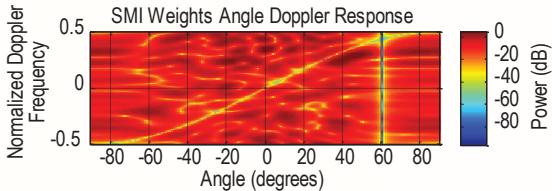

Ultra-Wideband Channelizer

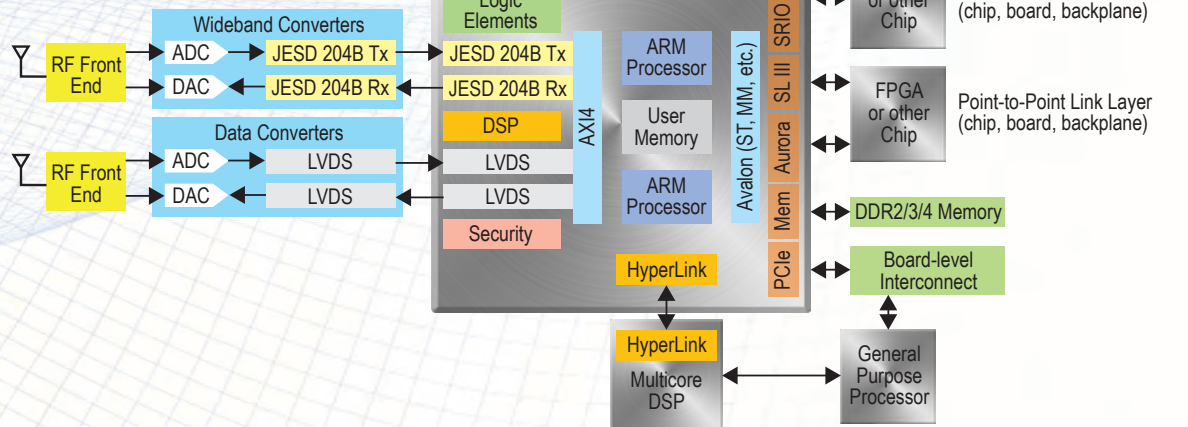
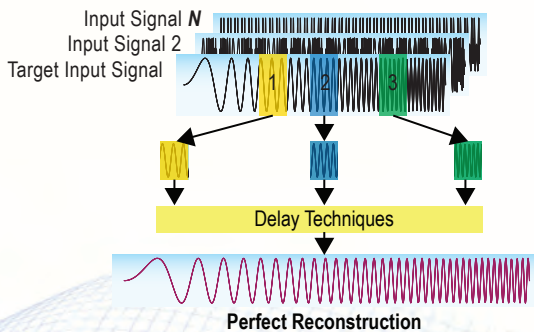

Altera Product Leadership

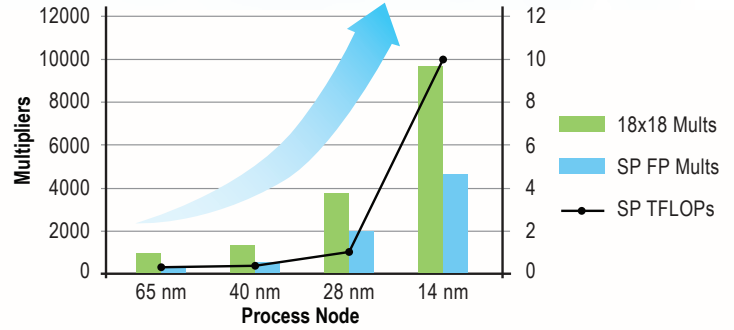

Military Security

- NIST AES-256 bitstream encryption
- NIST HMAC SHA-256 bitstream authentication
- Hard configuration error detection and correction
- On-chip voltage and temperature sensors
- 64 bit unique device ID
- Type-I and CSfC compliant solutions
- Security Supervisor IP (SSIP)
- Robust cryptographic partner IP

Commitment to Defense Industry

- Domestic fabrication — 14 nm Intel partnership
- Dedicated engineering support
- Pin-compatible migration (device migration)

Reliability and Longevity

- Industry's longest product life cycle
- Test above industry standard for package quality
- Leaded packages
- Broad selection of military temperature devices
- Latch-up immune

Integration

Baseboard Digital Processing

Test Drive Altera Today!

Military Solutions:

www.altera.com/end-markets/military-aerospace/mil-index.html

Product Selector:

www.altera.com/products/selector/psg-index.html

IP and Reference Designs:

www.altera.com/products/ip/ipm-index.html

Training:

www.altera.com/education/edu-index.html

Purchasing:

www.altera.com/buy/buy-index.html

Contact:

mil@altera.com

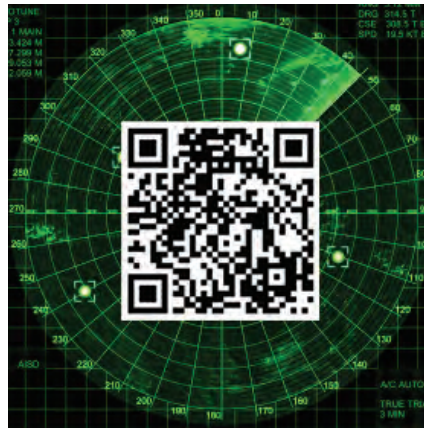

Learn More About Altera Military Solutions

<http://www.altera.com/b/military-design-solutions.html>

Altera Corporation

101 Innovation Drive
San Jose, CA 95134
USA

www.altera.com

Altera European Headquarters

Holmers Farm Way
High Wycombe
Buckinghamshire
HP12 4XF
United Kingdom
Telephone: (44) 1494 602000

Altera Japan Ltd.

Shinjuku i-Land Tower 32F
6-5-1, Nishi-Shinjuku
Shinjuku-ku, Tokyo 163-1332
Japan
Telephone: (81) 3 3340 9480
www.altera.co.jp

Altera International Ltd.

Unit 11-18, 9/F
Millennium City 1, Tower 1
388 Kwun Tong Road
Kwun Tong
Kowloon, Hong Kong
Telephone: (852) 2945 7000

